

5024G

Options Guide

Modbus TCP

5024G LCD weighing terminal

Modbus TCP option: Direct connection



Software: StdLim.140630.6v6m
Doc. no.: StdLim-140630-6v6-OG-ModbusTCP-eng
Date: 2023-08-29
Rev.: 6v6

Contact:
Eilersen Electric A/S
Kokkedal Industripark 4
DK-2980 Kokkedal
Denmark
www.eilersen.com
info@eilersen.com
Tel: +45 49 180 100
Fax: +45 49 180 200

Contents

Contents	2
Introduction	4
How to	4
– Configure Modbus TCP settings on 5024G	4
Address settings	4
Enable Modbus TCP protocol	5
– Monitor Modbus TCP data on 5024G	5
Protocol description	6
– Modbus TCP communication using PPO	6
MDS_PCA	7
PNU	8
PVA	8
CTW/STW	8
MRV/MAV	8
– Communication overview (Modbus data registers)	9
– RS – Reference Value Selector, MRV – Main Reference Value	10
– AS – Actual Value Selector, MAV – Main Actual Value	10
– CTW – Control Word	10
– STW – Status Word	11
– Parameters	12
Trouble shooting	13
Appendices	14
Appendix A – Screens overview	14
Appendix B – Electrical connection of 5024G to Modbus TCP	15
Ethernet communication connector on 5024G	15
Appendix C – Default Ethernet settings	15
Appendix D – Reading of Modbus data	16
Telegram format (Read Holding Register – 1 point)	16
Telegram format (Read Holding Register – 2 points)	16
Appendix E – Writing of Modbus data	17

Telegram format (Preset Multiple Registers – 1 register)	17
Telegram format (Preset Multiple Registers – 2 registers)	18
Revision History	19
Contact	20

Introduction

This document describes the use of the Modbus TCP option on the 5024G Weighing Terminal from Eilersen Electric. With the software version stated on the front page and with the Modbus TCP option enabled the system can communicate with an external controller/PLC using Modbus TCP, where the 5024G terminal acts as a Modbus TCP slave.

With the stated software version installed the 5024G terminal can transfer 7 output word registers (14 output bytes) from the Modbus TCP master to the 5024G terminal and transfer 7 input word registers (14 input bytes) from the 5024G terminal to the Modbus TCP master.

Exchange of data between 5024G terminal and the external controller/PLC is made according to the profile/protocol described later (see **Protocol description**).

This manual only describes the Modbus TCP option. For general information on the operation of the 5024G please see the 'Users guide'.

How to

– Configure Modbus TCP settings on 5024G

For the terminal to perform Modbus TCP communication directly on its RJ45/Cat5 Ethernet connector (J7) with a connected Modbus TCP master the Ethernet settings must be configured, and the Modbus TCP protocol must be enabled as described in the following.

Address settings

Ip addresses, subnet masks etc. are normally set from a PC with the EEConnect software. Please refer to the EEConnect documentation for further details.

If the terminal is unreachable e.g. due to network topology, the Ethernet settings can be entered in the **SETUP ETHERNET** screen:

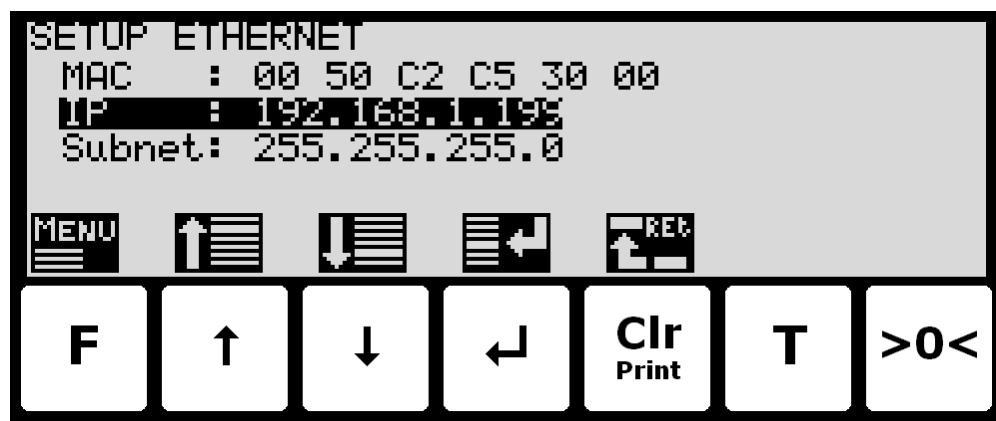

Enable Modbus TCP protocol

The Modbus TCP protocol must be enabled. This is done in the **ETHERNET PROTOCOLS** screen shown below:

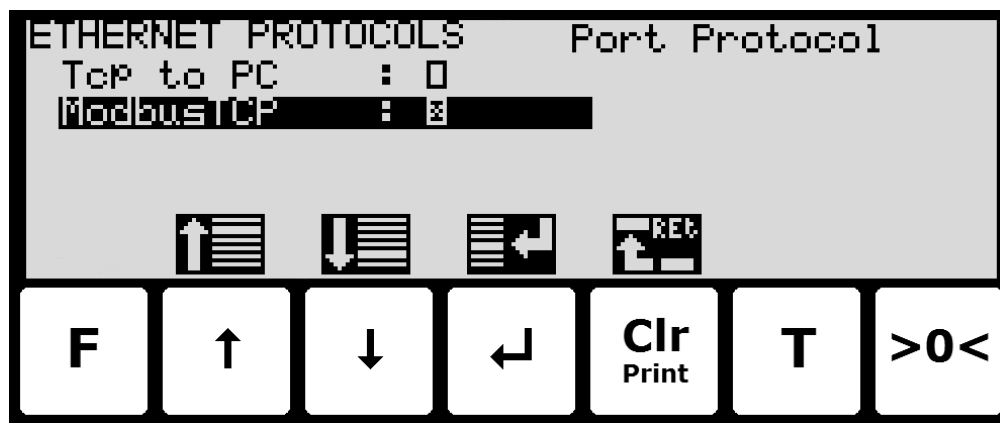

In the **ETHERNET PROTOCOLS** screen the 'ModbusTCP' parameter is selected using the cursor, and  is pressed to enable or disable the Modbus TCP protocol. A **X** in the corresponding box indicates the protocol is enabled. From the appearing menu it is also possible to switch to the **MODBUS TCP DATA** screen.

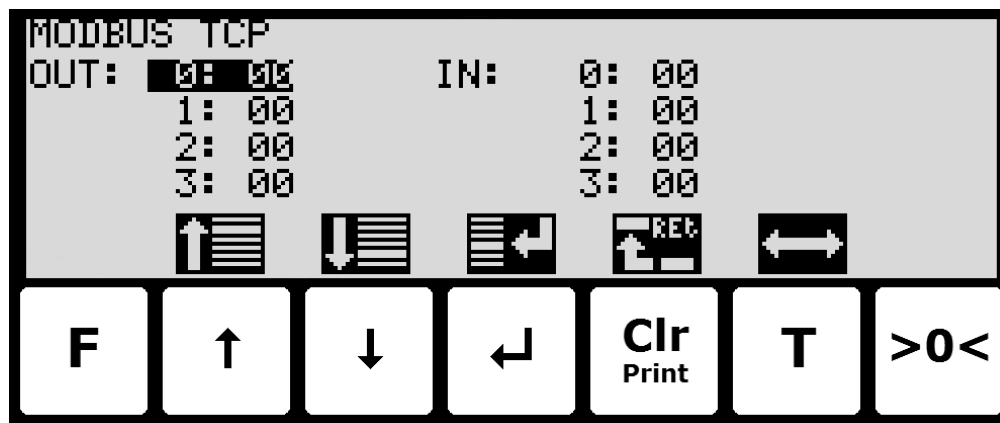

– Monitor Modbus TCP data on 5024G

Below the **MODBUS TCP DATA** screen is shown when this is selected using the  key from the **ETHERNET PROTOCOLS** screen.



This screen will show the data sent to the Modbus TCP master (*OUT*) and the data received from the Modbus TCP master (*IN*).

The following keys can be used for the described special functions:

-  &  Moves the cursor up and down between the output and input bytes.
-  Toggles the cursor between the output and the input bytes.

Protocol description

– Modbus TCP communication using PPO

The Modbus TCP communication is made using a 'parameter-process data object' (PPO) consisting of 7 output word registers followed by 7 input word registers. This object is used during both reception and transmission of data. The structure consists of the following registers:

Starting Address	Holding Register	Number of Points/Registers	Byte Count	Register Type	Register Content
Write data (From Modbus TCP master to 5024G):					
0	40001	1	2	2, Rd/Wr	MDS_PCA
1	40002	1	2	2, Rd/Wr	PNU
2	40003	2	4	4, Rd/Wr	PVA
4	40005	1	2	2, Rd/Wr	CTW
5	40006	2	4	4, Rd/Wr	MRV
Read data (From 5024G to Modbus TCP master):					
7	40008	1	2	2, Rd	MDS_PCA
8	40009	1	2	2, Rd	PNU
9	40010	2	4	4, Rd	PVA
11	40012	1	2	2, Rd	STW
12	40013	2	4	4, Rd	MAV

where:

MDS_PCA stands for Mode Selector and Parameter Characteristics

PNU stands for Parameter Number

PVA stands for Parameter Value

CTW stands for Control Word

MRV stands for Main Reference Value

STW stands for Status Word

MAV stands for Main Actual Value

In the following the meaning of the individual registers of the object is explained further.



IMPORTANT: During transfer/reception of data (i.e. the MAV) it is up to the master (the PLC) to ensure consistent data, when a parameter consisting of several word registers is read/updated and when AS/MAV or RS/MRV is read/set.

MDS_PCA

The MDS part is the most significant byte (MSB) of the MDS_PCA register, and indicates which value is to be transferred as **Main Reference Value** (MRV) and as **Main Actual Value** (MAV).

The PCA part is the least significant byte (LSB) of the MDS_PCA register and determines (along with the PNU and PVA registers) what is to happen with a given parameter.

MDS								PCA							
15	14	13	12	11	10	9	8	7	6	5	4	3	2	1	0
RS				AS				RC							

RS: Reference value selector (Values: 0..15)

AS: Actual value selector (Values: 0..15)

RC: Request/Response Characteristics (Values: 0..255)

MDS contains an RS part for selection of **Main Reference Value** (MRV) and an AS part for selection of **Main Actual Value** (MAV).

The PCA part contains an RC part for 'request' and 'response' indication during write and read.

RC is used by the master to tell the slave which 'request' is desired. Similarly, the slave uses RC to inform the master the status of the received 'request' ('response').

The contents of RC has the following function during 'request':

REQUEST	FUNCTION
0	No request
1	Request parameter value
2	Change parameter value in word register (2 bytes)
3	Change parameter value in double word register (4 bytes)
<i>Others</i>	<i>Reserved for future use</i>

The contents of RC has the following function during response:

RESPONSE	FUNCTION
0	No response
1	Transfer parameter value in word register (2 bytes)
2	Transfer parameter value in double word register (4 bytes)
3	Request rejected (incl. Error#, see later)
4	Cannot be serviced by PCA, PNU and PVA interface
<i>Others</i>	<i>Reserved for future use</i>

PNU

The PNU part indicates the parameter number of the parameter to be read/changed. The parameters and their function are described below.

PVA

The PVA part contains a double word for reception and transmission of parameter values. The PVA part transfers single word parameters in the least significant word (LSW).

If the slave rejects a request from the master the RC part assumes the value 3 (see above) and the error number itself is transferred in the least significant word (LSW) of the PVA register. The following error indications are possible:

ERROR #	CAUSE
0	Illegal command for this PNU or PNU not used.
1	<i>Reserved for future use</i>
2	Upper or lower limit exceeded

CTW/STW

During communication from the master to the slave a Control Word (CTW) is used. Using the Control Word (CTW) it is possible to tell the slave how to react as different commands can be transferred to the slave.

During communication from the slave to the master a Status Word (STW) is used. Using the Status Word (STW) it is possible for the master to gain information on the status of the slave.

MRV/MAV

During communication from the master to the slave a **Main Reference Value** (MRV) is used; a setpoint. Using the RS defines exactly which value is transferred as MRV.

During communication from the slave to the master a **Main Actual Value** (MAV) is used; the actual value. Using the AS defines exactly which value is transferred as MAV.

– Communication overview (Modbus data registers)

Below is a complete list of data registers available on 5024G weighing terminal. The list specifies the *Starting Address*, the *Holding Register*, the *Number of Points/Registers*, the *Byte Count*, the *Register Type* (register size in bytes and if it's a Read/Write register) as well as the *Register Content*.

Starting Address	Holding Register	Number of Points/Registers	Byte Count	Register Type	Register Content
Write data (From Modbus TCP master to 5024G):					
0	40001	1	2	2, Rd/Wr	MDS_PCA
1	40002	1	2	2, Rd/Wr	PNU
2	40003	2	4	4, Rd/Wr	PVA
4	40005	1	2	2, Rd/Wr	CTW
5	40006	2	4	4, Rd/Wr	MRV
Read data (From 5024G to Modbus TCP master):					
7	40008	1	2	2, Rd	MDS_PCA
8	40009	1	2	2, Rd	PNU
9	40010	2	4	4, Rd	PVA
11	40012	1	2	2, Rd	STW
12	40013	2	4	4, Rd	MAV

Please note the following:

1. All weights are transferred as shown in the display without a decimal point (i.e. 300.0 kg is transferred as 3000 and 67.2 kg is transferred as 672).
2. All negative numbers are transferred as 2-complement numbers.
3. Actual unit and decimal point position can be read from the appropriate parameter.
4. In Modbus TCP communication the **Most Significant Byte** (MSB) of a word is first.
5. In Modbus TCP communication the **Least Significant Word** (LSW) of a double word is first.
6. When reading/transferring data consisting of multiple holding registers (such as gross and net weight in the MAV part) it is up to the Modbus master to ensure consistent data (data originate from the same telegram). This is typically done by performing a "Read Holding Register" command requesting the read of 2 points (for a double word such as gross or net weight) and then determining the actual result from the response telegram. In similar way the transfer of a double word parameter should be done using a single "Preset Multiple Registers" command requesting the write/update of 2 registers.

– RS – Reference Value Selector, MRV – Main Reference Value

RS Reference Value Selector	MRV Main Reference Value
0	Not used
Others	Not used

– AS – Actual Value Selector, MAV – Main Actual Value

AS Actual Value Selector	MAV Main Actual Value
0	Not used
1	Actual gross weight
2	Actual net weight
Others	Not used

Actual gross weight is the actual gross weight on the 5024G terminal.

Actual net weight is the actual net weight on the 5024G terminal.

– CTW – Control Word

Bit	Function
0	Zero
1	Autotare (zero of net weight)
2	Start dosing
3	Stop dosing
4	Registration
Others	Not used

Zero must be activated if a zero of the gross weight is desired.

Autotare must be activated if a zero of the net weight is desired.

Start dosing must be activated if a start of dosing is desired.

Stop dosing must be activated if a dosing is to be stopped before the fine limit is reached. If the terminal is set to perform automatic registration on time this will take place afterwards.

Registration must be activated if a registration of the actual net weight is desired. Any dosing in progress will be aborted before registration.

- STW – Status Word

Bit	Function
0	Weight reading not possible
1	Zero OK
2	Zero not possible
3	Autotare OK
4	Autotare not possible
5	Start dosing OK
6	Start dosing not possible
7	Stop dosing OK
8	Stop dosing not possible
9	Registration OK
10	Registration not possible
11	Fine dosing
12	Coarse dosing
13	<i>Not used</i>
14	Registration ready
15	OK – always ON

Weight reading not possible is active when the 5024G terminal is unable to determine weight.

Zero OK is active when zero was possible.*)

Zero not possible is active when zero was NOT possible.*)

Autotare OK is active when autotare was possible.*)

Autotare not possible is active when autotare was NOT possible.*)

Start dosing OK is active when start of dosing was possible.*)

Start dosing not possible is active when start of dosing was NOT possible.*)

Stop dosing OK is active when stop of dosing was possible.*)

Stop dosing not possible is active when stop of dosing was NOT possible.*)

Registration OK is active when registration of net weight was possible.*)

Registration not possible is active when registration of net weight was NOT possible.*)

Fine dosing is active during dosing until the fine limit (pos. adjusted for afterflow) is reached.

Coarse dosing is active during dosing when the net weight is below the coarse limit.

Registration ready is active when a registration is ready. The bit is cleared when a new dosing is started.

OK – always ON is always activated. Can be used as a control of the communication.

Bits marked with *) are cleared again when the corresponding request bit is cleared.

– Parameters

NO	TYPE	PARAMETER
1	4, R	Actual gross weight
2	4, R	Actual net weight
3	4, RW	Fine limit
4	4, RW	Coarse limit
5	-	<i>Not used</i>
6	4, R	Last registered amount
7	4, R	Total dosed amount
8	4, R	Total number of weighings
10	2, R	Unit <i>0: kg</i> <i>1: lbs</i> <i>2: gram</i>
11	2, R	Decimal point position
20 – 35	2, R	Load cell-Status[x]
40 – 55	4, R	Load cell-Gross[x]
<i>Others</i>		<i>Not used</i>

Actual gross weight is the actual gross weight on the 5024G terminal.

Actual net weight is the actual net weight on the 5024G terminal.

Fine limit contains the fine limit used during dosing.

Coarse limit contains the coarse limit used during dosing.

Last registered amount contains the result (registration) of the last dosing.

Total dosed amount contains the total dosed amount.

Total number of weighings contains the total number of weighings.

Unit indicates the unit used in the display reading. It should be used to scale weight indications received/transmitted using the Modbus TCP communication.

Decimal point position indicates the number of digits after the decimal point in the display reading. It should be used to scale weight indications received/transmitted using the Modbus TCP communication.

Load cell-Status[x] contains the actual status for load cell x.

Load cell-Gross[x] contains the actual gross signal (not zeroed) on load cell x.

Trouble shooting

Problem	Explanation and possible solutions
<i>PLC unable to receive/transmit data from/to 5024G</i>	Check connection between PLC and 5024G terminal is ok (see below). Check configuration of 5024G terminal is ok (see below). Check configuration of Modbus TCP master (PLC) is ok (see below).
<i>No connection between PLC and 5024G terminal</i>	Check the power to the 5024G as well as switches between PLC and 5024G. Check the Ethernet cable is connected correctly to both PLC and 5024G. Check the Ethernet cable is not damaged. Check status for the green and yellow lamps on the Ethernet connectors.
<i>Wrong configuration of 5024G terminal</i>	Check parameters in SETUP ETHERNET screen are configured correctly: - Check " IP " parameter matches the desired IP address. - Check " Subnet " parameter matches the desired Subnet mask. Check " Modbus TCP " protocol is enabled in the ETHERNET PROTOCOLS screen.
<i>Wrong configuration of PLC</i>	Check the PLC is configured correctly. In this application 7 output word registers and 7 input word registers are used. Check the PLC is configured using the correct IP address and Subnet mask.
<i>Values change rapidly between random values</i>	Check the Modbus TCP master (PLC) uses correct data format: - in word registers Most Significant Byte (MSB) is first, and Least Significant Byte (LSB) is last. - in double words Least Significant Word (LSW) is first, and Most Significant Word (MSW) is last.
<i>Implemented protocol does not behave as expected</i>	Compare implemented Modbus TCP protocol (PLC program) with the Modbus TCP protocol description above. For instance, check if the OK – always ON bit in STW is ON as expected.
<i>Implemented protocol does not behave as expected</i>	Use the MODBUS TCP DATA screen to debug 5024G received data from PLC (IN) results in expected transmit data to PLC (OUT).

Appendices

Appendix A – Screens overview

The system has the following screens, which are selected using the menu system.

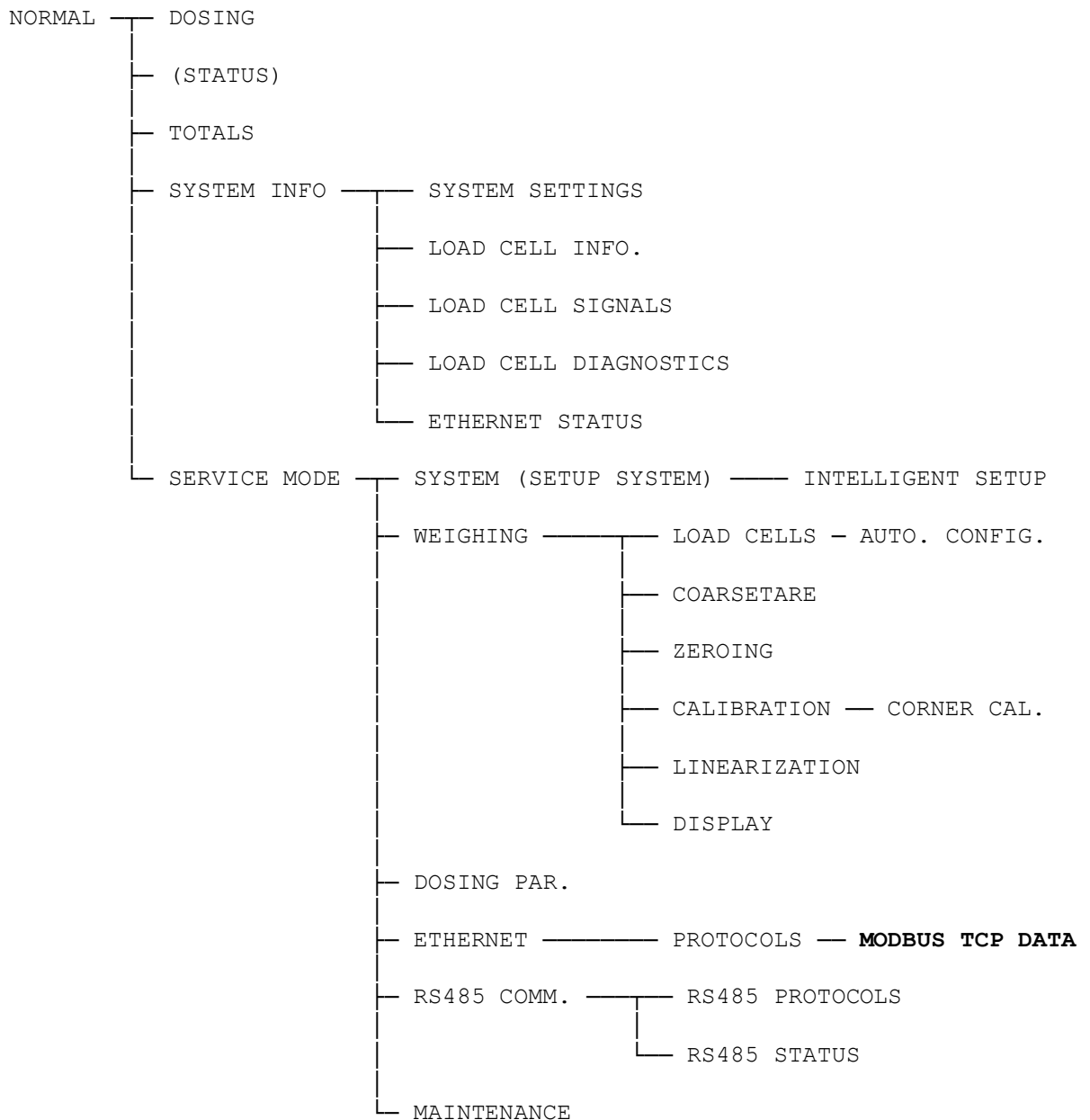

Appendix B – Electrical connection of 5024G to Modbus TCP

The following describes the electrical connection of the 5024G terminal to Modbus TCP.

Ethernet communication connector on 5024G

The RJ45/Cat5 Ethernet connector (J7) on the backside of the 5024G terminal is a standard Ethernet connector that is used to connect the 5024G system to the Modbus TCP master.

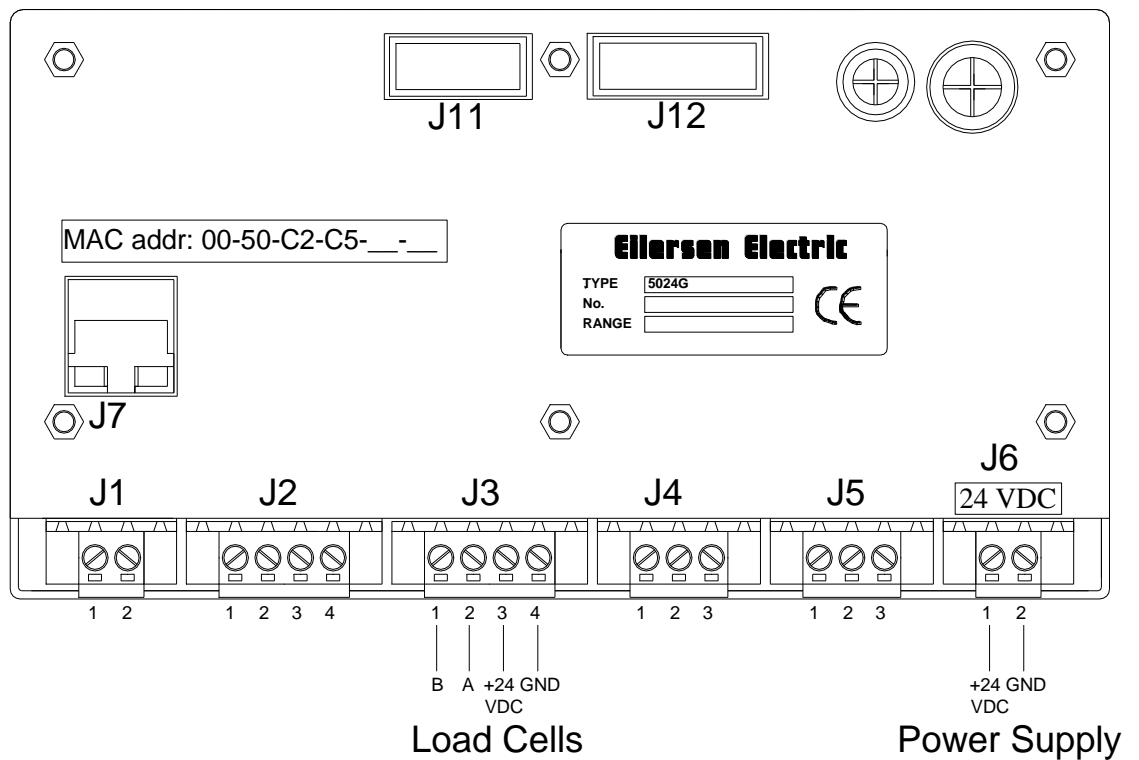

Appendix C – Default Ethernet settings

The MAC address of the 5024G terminal is preset to a unique value within the Eilersen Electric A/S range. The default settings for IP address, Subnet mask etc. are:

IP address:	192.168.1.199
Subnet mask:	255.255.255.0
Port number:	502 (Modbus TCP default)

Appendix D – Reading of Modbus data

Modbus data registers on the 5024G weighing terminal are read by the Modbus Master by performing a "Read Holding Register" request (0x03) to the 5024G weighing terminal. The *Holding Register* as well as the *Number of Points* used in the request is specified for each data register in the Modbus data register table shown earlier.

Telegram format (Read Holding Register – 1 point)

A "Read Holding Register" command requesting the read of 1 point from start address 1 (Holding Register 40002) has the following telegram format:

	<u>HEX</u>	<u>ASCII (chars)</u>		<u>RTU (binary)</u>
Header:	xx	:		none
Slave Adr.:	xx	x	x	xxxxxxxx
Function:	03	0	3	00000011
Start Adr. (H):	00	0	0	00000000
Start Adr. (L):	01	0	1	00000001
# of points (H):	00	0	0	00000000
# of points (L):	01	0	1	00000001
Error Check:	xx	LRC (2 bytes)		CRC (2 bytes)
Trailer:	xx	CR	LF	none

To this request the 5024G terminal responds with the following telegram:

	<u>HEX</u>	<u>ASCII (chars)</u>		<u>RTU (binary)</u>
Header:	xx	:		none
Slave Adr.:	xx	x	x	xxxxxxxx
Function:	03	0	3	00000011
Byte Count:	02	0	2	00000010
Data0 (H)	xx	x	x	xxxxxxxx
Data0 (L)	xx	x	x	xxxxxxxx
Error Check:	xx	LRC (2 bytes)		CRC (2 bytes)
Trailer:	xx	CR	LF	none

Telegram format (Read Holding Register – 2 points)

A "Read Holding Register" command requesting the read of 2 points from start address 2 (Holding Register 40003) has the following telegram format:

	<u>HEX</u>	<u>ASCII (chars)</u>		<u>RTU (binary)</u>
Header:	xx	:		none
Slave Adr.:	xx	x	x	xxxxxxxx
Function:	03	0	3	00000011
Start Adr. (H):	00	0	0	00000000
Start Adr. (L):	02	0	2	00000010
# of points (H):	00	0	0	00000000
# of points (L):	02	0	2	00000010
Error Check:	xx	LRC (2 bytes)		CRC (2 bytes)
Trailer:	xx	CR	LF	none

To this request the 5024G terminal responds with the following telegram:

	<u>HEX</u>	<u>ASCII (chars)</u>		<u>RTU (binary)</u>
Header:	xx	:		none
Slave Adr.:	xx	x	x	xxxxxxxx
Function:	03	0	3	00000011
Byte Count:	04	0	4	00000100
Data0 (H) (LSW)	xx	x	x	xxxxxxxx
Data0 (L) (LSW)	xx	x	x	xxxxxxxx
Data1 (H) (MSW)	xx	x	x	xxxxxxxx
Data1 (L) (MSW)	xx	x	x	xxxxxxxx
Error Check:	xx	LRC (2 bytes)		CRC (2 bytes)
Trailer:	xx	CR	LF	none

Appendix E – Writing of Modbus data

Modbus data registers on the 5024G weighing terminal are written by the Modbus Master by performing a "Preset Multiple Registers" request (0x10) to the 5024G weighing terminal. The *Holding Register*, the *Number of Registers* as well as the *Byte Count* used in the request is specified for each data register in the Modbus data register table shown earlier.

Telegram format (Preset Multiple Registers – 1 register)

A "Preset Multiple Registers" command requesting the write/update of 1 register from start address 0 (Holding Register 40001) has the following telegram format:

	<u>HEX</u>	<u>ASCII (chars)</u>		<u>RTU (binary)</u>
Header:	xx	:		none
Slave Adr.:	xx	x	x	xxxxxxxx
Function:	10	1	0	00010000
Start Adr. (H):	00	0	0	00000000
Start Adr. (L):	00	0	0	00000000
# of registers (H):	00	0	0	00000000
# of registers (L):	01	0	1	00000001
Byte Count:	02	0	2	00000010
Data0 (H)	xx	x	x	xxxxxxxx
Data0 (L)	xx	x	x	xxxxxxxx
Error Check:	xx	LRC (2 bytes)		CRC (2 bytes)
Trailer:	xx	CR	LF	none

To this request the 5024G terminal responds with the following telegram:

	<u>HEX</u>	<u>ASCII (chars)</u>		<u>RTU (binary)</u>
Header:	xx	:		none
Slave Adr.:	xx	x	x	xxxxxxxx
Function:	10	1	0	00010000
Start Adr. (H):	00	0	0	00000000
Start Adr. (L):	00	0	0	00000000
# of registers (H):	00	0	0	00000000
# of registers (L):	01	0	1	00000001
Error Check:	xx	LRC (2 bytes)		CRC (2 bytes)
Trailer:	xx	CR	LF	none

Telegram format (Preset Multiple Registers – 2 registers)

A "Preset Multiple Registers" command requesting the write/update of 2 registers from start address 6 (Holding Register 40007) has the following telegram format:

	<u>HEX</u>	<u>ASCII (chars)</u>		<u>RTU (binary)</u>
Header:	xx	:		none
Slave Adr.:	xx	x	x	xxxxxxxx
Function:	10	1	0	00010000
Start Adr. (H):	00	0	0	00000000
Start Adr. (L):	06	0	6	00000110
# of registers (H):	00	0	0	00000000
# of registers (L):	02	0	2	00000010
Byte Count:	04	0	4	00000100
Data0 (H) (LSW)	xx	x	x	xxxxxxxx
Data0 (L) (LSW)	xx	x	x	xxxxxxxx
Data1 (H) (MSW)	xx	x	x	xxxxxxxx
Data1 (L) (MSW)	xx	x	x	xxxxxxxx
Error Check:	xx	LRC (2 bytes)		CRC (2 bytes)
Trailer:	xx	CR	LF	none

To this request the 5024G terminal responds with the following telegram:

	<u>HEX</u>	<u>ASCII (chars)</u>		<u>RTU (binary)</u>
Header:	xx	:		none
Slave Adr.:	xx	x	x	xxxxxxxx
Function:	10	1	0	00010000
Start Adr. (H):	00	0	0	00000000
Start Adr. (L):	06	0	6	00000110
# of registers (H):	00	0	0	00000000
# of registers (L):	02	0	2	00000010
Error Check:	xx	LRC (2 bytes)		CRC (2 bytes)
Trailer:	xx	CR	LF	none

Revision History

Date	Author	Rev.	Update
2018-11-28	HJA	4v0	<i>Initial document created and adapted. (based on StdLim-140630-2v4-OG-ModbusTCP-eng)</i>
2019-01-10	HJA	5v0	<i>Based on StdLim-140630-4v0-OG-ModbusTCP-eng, but: Adapted screens overview in Appendix A.</i>
2019-02-19	HJA	5v1	<i>Updated references to software ID.</i>
2019-04-24	jk	5v2	<i>Updated references to software ID.</i>
2019-05-20	jk	5v3	<i>Updated references to software ID.</i>
2019-09-03	HJA	5v4	<i>Added Intelligent Setup to screens overview.</i>
2020-02-18	HJA	5v6	<i>Added ETHERNET STATUS screen in overview.</i>
2020-09-08	HJA	5v7	<i>Updated references to software ID.</i>
2021-02-11	HJA	5v8	<i>Updated references to software ID.</i>
2021-05-07	HJA	6v0	<i>Updated references to software ID.</i>
2021-11-12	HJA	6v0a	<i>Added MAINTENANCE screen to screens overview.</i>
2022-01-19	HJA	6v1	<i>Updated references to software ID.</i>
2022-03-29	HJA	6v2	<i>Updated references to software ID.</i>
2022-11-28	HJA	6v3	<i>Updated references to software ID.</i>
2023-02-06	HJA	6v3a	<i>Added appendix for default Ethernet settings.</i>
2023-02-23	HJA	6v4	<i>Updated references to software ID.</i>
2023-05-30	HJA	6v5	<i>Added MODBUS TCP DATA screen.</i>
2023-08-29	HJA	6v6	<i>Added new RS485 COMMUNICATION , PROTOCOLS and STATUS screens.</i>

Contact

With further questions or improvement suggestions please contact us:

Eilersen

The Weighing Experts

Eilersen Electric A/S
Kokkedal Industripark 4
DK-2980 Kokkedal
Denmark
www.eilersen.com
info@eilersen.com
Tel: +45 49 180 100
Fax: +45 49 180 200

Eilersen
The Weighing Experts